

# Lampade GETSL / GETSL Lamps

Alluminio 17,5mm coperture policarbonato, supporti di fissaggio clip o fissaggi aperti (-FA) - Aluminum 17,5mm covers polycarbonate, mounting brackets clips or fasteners open (-FA)

Mod. GETSL	Lunghezza Length	N° Led	Moduli base integrati 6 led Standard modules 6 integrated Led	Tensione alimentazione Supply voltage	Corrente alimentazione Supply current	Potenza assorbita Power consumption	Flusso lum. generata tipica Typical luminous flux	illuminazione tipica a 50cm Typical 50 cm Lighting	Range temperatura lavoro Working temperature range
GETSL09-6K-T GETSL09-6K-OP	09 cm.	6	1	24Vdc +/- 10%.	85 mA	2,0 W	210 lumen	250 lux 180 lux	Da -35(no frost ) a +55°C
GETSL18-6K-T GETSL18-6K-OP	18 cm.	12	2		170 mA	4,0 W	420 lumen	490 lux 340 lux	
GETSL25-6K-T GETSL25-6K-OP	25 cm.	18	3		250 mA	6,0 W	630 lumen	710 lux 490 lux	
GETSL42-6K-T GETSL42-6K-OP	42 cm.	30	5		425 mA	10,2 W	1050 lumen	1080 lux 750 lux	
GETSL50-6K-T GETSL50-6K-OP	50 cm.	36	6		500 mA	12,0 W	1260 lumen	1250 lux 870 lux	
GETSL100-6K-T GETSL100-6K-OP	100 cm.	72	12		1000 mA	24,0 W	2520 lumen	1820 lux 1200 lux	
GETSL200-6K-T GETSL200-6K-OP	200 cm.	144	24		2000 mA	48,0 W	5040 lumen	1950 lux 1430 lux	

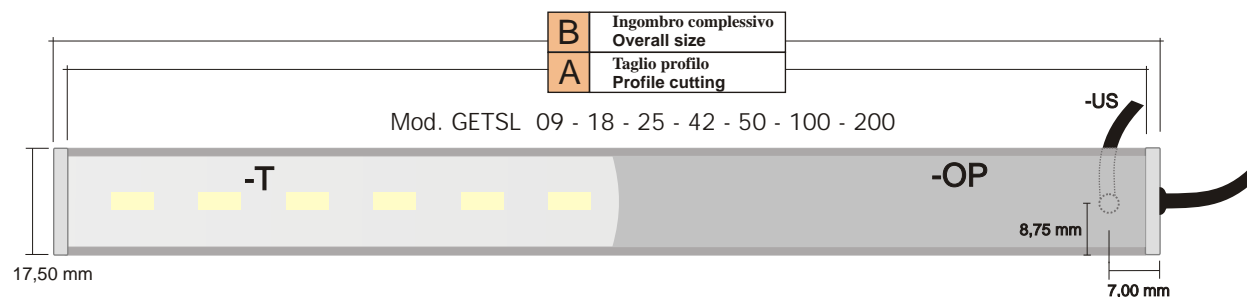
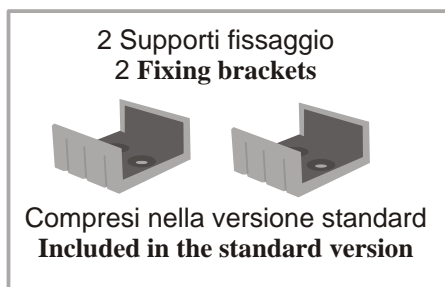

Mod.	A (mm)	B (mm)
GETSL09	90	93
GETSL18	177	180
GETSL25	255	258
GETSL42	420	423
GETSL50	498	501
GETSL100	1000	1003
GETSL200	2000	2003
GETSLXX	Lunghezze custom Lengths custom	

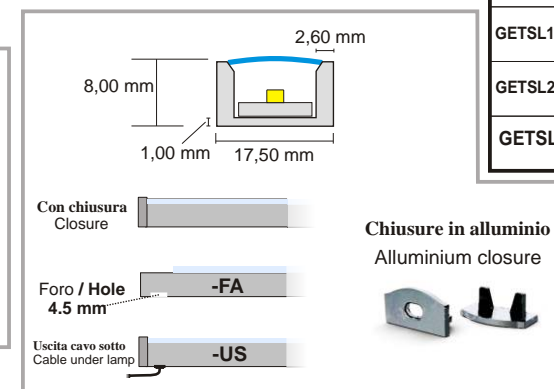
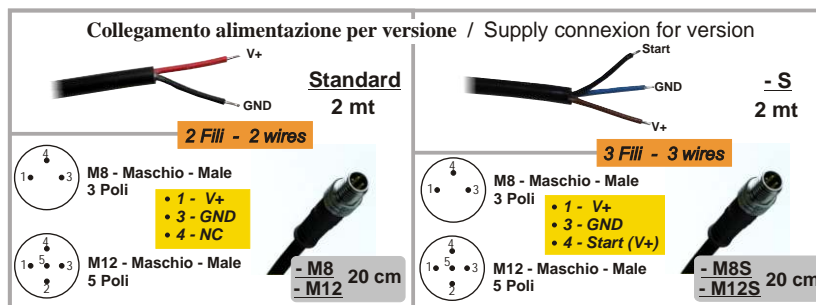
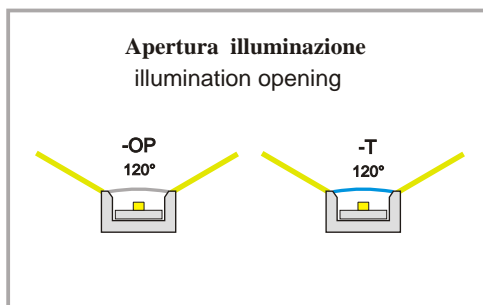

Normative / Standards	
Immunità elettromagnetica - EMC immunity :	EN 61547:2009
Emissione elettromagnetica - EMC emission :	EN 55015:2006
Rischio fotobiologico - Photobiologic risk :	EN 62471:2010 GLS: RISK EXEMPT
Assessment of lighting equipment related to human exposure to electromagnetic fields	EN 62493:2010



V. Bachelet, 3/A - 41057 Spilamberto - MODENA -  
Tel. 059785566 - info@genesi-lux.it - www.genesi-lux.it



## Lampada Led / Led lamp

- Alimentazione: 24 Vdc  
Supply: 24Vdc
- Grado di protezione: IP54  
Protection degree: IP54
- Uso illuminazione / Use lighting
- Illuminatore sistemi ispezione con telecamere  
Ulight camera inspection system

## Opzioni GETSL / GETSL Options

Ex. Code :GETSLXX-YY-CCC-WW1-WW2-WW3-WW4

Code GETSL			
Lunghezza lampada Lamp length	Colore Led Led Color	Corrente per Led Current for Led	Varianti e opzioni Variants and options
XX	YY	CCC	WW

-WW1	Moduli integrati controllo Led Integrated control module led
-DIM1	Dimmer integrato 1 Via Integrated dimmer 1-way
-DIM2	Dimmer integrato 2 Via Integrated dimmer 2-way
-AS5	Amplificatore e Controllo impulso accensione, solo uso Impulsivo. Amplifier and pulse ignition control, use only Impulsive

-WW2 Varianti coperture Lampada Lamps cover variants	
-T <small>STANDARD</small>	Copertura Trasparente 5mm Transparent cover 5mm
-OP	Copertura Opalina 5mm Opal 5mm

-WW3 Varianti Lampada Lamps variants	
-FA	Fisaggio aperto a vista - Fixing open to view
-US	Uscita cavo sotto lampada - Cable under lamp
-BT	Fisaggio con biadesivo fornito con lampada Fixing with adhesive tape supplied with lamp

-WW4 Collegamento alimentazione per versione Supply connexion for version	
- <small>STANDARD</small>	Versione standard cavo 2 poli 2mt 2mt 2-poles cable standard version
-M8	Versioni -M8 conn. M8 3 poli Maschio cavo 20cm -M8 versions M8 3-poles 20 cm male conn
-M12	Versioni -M12 conn. M12 5 poli Maschio cavo 20cm -M12 versions M12 5-poles 20 cm male conn
-S	Ver. -S (pin di Start/Strobe/Dimmer) corr. pil. max 10mA, cavo 3 poli 2mt
-M8S	Ver. -M8S (pin di Start/Strobe/Dimmer) corr. pil. max 10mA, M8 3 poli M 20cm
-M12S	Ver. -M12S (pin di Start/Strobe/Dimmer) corr. pil. max 10mA, M12 5 poli Maschio 20cm
-5M	cavo 2 poli 5mt / 5mt 2 poles cable
-5MS	cavo 3 poli 5mt / 5mt 3 poles cable
-WW	Versioni custom Custom versions

Lunghezza lampada Lamp length	
GETSL09	09 cm
GETSL18	18 cm
GETSL25	25 cm
GETSL42	42 cm
GETSL50	50 cm
GETSL100	100 cm
GETSL200	200 cm
GETSLXX	custom

Colori Colours	
-6K <small>STANDARD</small>	Bianco freddo 6000K 6000K Cold white
-4K	Bianco Naturale 4000K 4000K Natural white
-3K	Bianco Caldo 3000K 3000K Warm white
-R625	Rosso/Red 625 nm
-B470	Blu 470nm
-Y591	Giallo/Yellow 591 nm
-G524	Verde/Green 524 nm
-IR730	IR 730 nm
-IR850	IR 850 nm
-IR950	IR 950 nm
-YY	custom

Corrente per Led Current for led	
- <small>STANDARD</small>	85mA per Led 85mA for Led
-20	20mA per Led 20mA for Led
-40	40mA per Led 40mA for Led
-120	120mA per Led 120mA for Led
-300	300mA per Led uso impulsivo 300mA for Led impulsive use T ON max 1/10
-400	400mA per Led uso impulsivo 400mA for Led impulsive use T ON max 1/10
-CCC	custom



GETSL25-6K-OP

GETSLXX-YY-OP-FA

GETSLXX-YY-OP-US

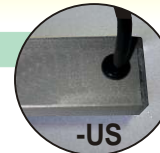
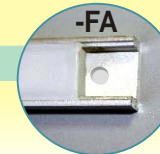

Design & Production  
Made in Italy  
CE



Genesi Elettronica srl

V. Bachelet, 3/A - 41057 Spilamberto - MODENA -  
Tel. 059785566 - info@genesi-lux.it

rev. 04/15

